



LUXMAN 800

SERVICE MANUAL 2800

R 800 CIRCUIT DESCRIPTION

Power Supply

The mains input to the Receiver goes via a 2 pole power switch to the mains transformer which has three secondary windings:

1. A 12-volt winding for the panel lamps.
2. A 60-volt centre tapped winding providing after full-wave rectification + and - supplies for the audio power amp section, and
3. A 30-0-30 volt winding to provide 45 volts DC for the preamp and tuner sections. A potential divider using a zener diode which is used to obtain from the 45 volts a 12 volt DC supply for the AM and FM tuner sections. The 2SC1345 transistor is used as a ripple filter providing 40 volts to the audio preamps.

There are fuses in all the secondaries for transformer protection. A fuse is used as well in the pre-amp.

POWER AMPS

PNP transistors are used as a differential comparator; the audio input is fed to the first transistor and the feedback to the other. NPN metal can transistors are used as active loads for the differential comparator, the one NPN has its collector to ground, the other being the voltage amplifier for the entire output stage, which uses a PNP driver and a PNP output in the negative side connected as a darlington emitter follower configuration, and an NPN driver and NPN output is used in the positive side. These 4 transistors form what is known as a fully complementary symmetrical output stage.

Their input bases are bias with a 3 diode device (SV03) and a bias trim pot for idling current set (35 mA), 2 resistors and a condenser form the bootstrap constant current load for the voltage amplifier to drive the output stage. The junction of the emitter resistors is as a feed point for the differential comparator, and at the same time goes via a 5 amp fuse to the speaker selector switch to the speaker terminals and headphone socket via 470 ohm.

The headphone socket is always active regardless of speaker selection. PNP and NPN transistors are used to sense output current and voltage and if the output is short circuited will limit the drive to the output devices, thereby protecting the amplifier from overload.

Input sensitivity of the power amp is defined by the ratio of R7136 RD12 which = 500 mv for full output, and the low frequency roll off is determined by the reactance of C706 to R712 which in this circuit is 10Hz.

PRE AMP

Phono RIAA equalization amplifier 2 phono inputs can be selected, both with the same input sensitivity. The RIAA amplifier uses a NPN and PNP direct coupled pair of tran-

sistors which are selected low noise types, the equalization and DC feedback are taken from the collector of the PNP back to the emitter of the input NPN transistor. This amp has a gain of 38 db (2.3 mv - 150 mv) at 1 KHz. The linearity of this direct coupled combination offers high overload capabilities (100 mv at 1 KHz).

The 150 mv nominal level is at the same level as the other functions.

The Mic amplifier uses basically the same circuit without equalization, being flat from 20 - 50 KHz with 38 db gain. The Function Switch selects AM, FM Aux 1 and 2 and Phono 1 and 2 the output of which can be mixed with the input from the mic amplifier. This audio then goes to the tape monitoring function switches.

There are two switches for the tape functions, these are mounted on the same printed circuit board as the tone control circuits. The left switch enables in the "up" position dubbing from tape 1 - 2 and in the "lower" position from Tape 2 - 1, when "centre", it is off. The right-hand switch enables monitoring from Tape 1 in the "up" position, tape 2 in the lower and programme source in the centre position.

The required selection will then go to the printed circuit board which contains a 2 transistor NPN, PNP direct coupled flat response amp with 12 db gain. Also contained on the same board are CR type 6 db/oct hi and low cut filters with hi cut selections of 6 KHz, 12 KHz and off and low cut selections of 70 Hz, 20 Hz and off. The switch for the loudness and bass boost, which is also on this board works in conjunction with the volume control so that the greatest effect is at low volume settings, the audio then passes on the tone control circuit.

TONE CONTROL BOARD

The tape functions previously described are mounted on this board. A NPN transistor is used in a Lux-type active bass and treble control, operating in a virtual earth mode with the input audio at the boost point of the controls and the base of the transistor fed from the slider of the bass control via C405, the collector being the feedback point to the controls and providing the output which is at unit gain with respect to the input to drive the power amplifier.

AM SECTION

A superhet design using a tuned RF amplifier, a mixer/local oscillator and two stages of IF amplification at 455 KHz. A ferrite rod antenna with 3 windings is used, the first winding is connected to the external antenna terminal, the second is connected to the first section of a 3 gang tuning condenser, the last winding feeding the base of the PNP transistor amplifier; a clamp diode is used to protect the

input against RF overload.

A tuned RF transformer is used to couple the collector to the base of the self-mixing oscillator. The oscillator operates at 455 KHz above the incoming signal to produce the intermediate frequency, which is passed through a ceramic filter and then amplified by two further transistor IF stages. The audio is then recovered by a germanium diode detector and passed on to the pre amp via the selector switch, and the signal strength meter is driven from the audio detector output.

A voltage doubler is used to provide an A.G.C. voltage which controls the gain of the first IF amplifier; the collector of this provides an amplified AGC back to the emitter of the RF transistor. This method used provides an audio output relatively constant with varying R.F. signal strength.

FM SECTION

An input balun transformer matches either 300 ohm or 75 ohm antenna input to the Front end, which has a 4 gang tuning capacitor and consists of a dual gate FET for the tuned RF amp feeding, via a two-section transformer, the bi-polar transistor mixer.

A bipolar transistor "Colpitts" oscillator operates at 10.7 mcs above the incoming signal. C115 is a negative temperature coefficient condenser to stabilize the oscillator to less than 25 KHz per 10 deg. Celsius. The output is then fed via a 1 pf condenser to the mixer, the resultant 10.7 MHz passes through a double tuned IFT included in the front end module.

The front end module is well shielded to prevent any spurious radiation, and to offer good image and selectivity responses.

IF

The IF strip is contained on the same printed circuit board as the stereo multiplex decoder and muting circuits.

The 10.7 MHz IF intermediate frequency is amplified by a transistor then passed through a ceramic filter with a side chain A.G.C. amplifier to provide a D.C. control voltage (A.G.C.) for the RF input FET to improve the front end overload capabilities. The main chain is again amplified by a further transistor and ceramic filter providing a wide pass band with steep sides.

A differential IC with a built-in constant current source provides partial limiting, this passing through an IF transformer into the final multistage I.C. which provides hard limiting characteristics for the ratio discriminator, which provides the composite audio output for the multiplex.

A second side chain amplifier and rectifier monitors the input to the first I.C. to provide a signal strength control command as well as driving the signal strength meter.

At the audio output when the receiver is off-tuned from

centre either a positive or negative D.C. will appear which is monitored both by a centre tune meter and a bi-phase detector using one NPN and one PNP transistor which with another NPN forms an "AND" gate for one of two "shmitt" trigger circuits. The other shmitt trigger receives a command from the signal strength circuit previously mentioned. The collectors of the final transistor in each circuit form a "wired OR" gate which via the muting "On-Off" switch on the front panel controls the gate on the FET audio mute circuit if it is enabled. The composite audio passes on to the I.C. multiplex, which will derive the L and R audio output, the IC also is connected directly to the stereo indicator lamp.

The Left and Right go through L.C. type rejection filters to remove the 19 KHz pilot. These are both in one moulding.

Finally, a one transistor amplifier is used in each channel to raise the level to 400 m volts for the audio pre amp. A de-emphasis switch has been incorporated on the P.C. board for selecting either 75 μ sec. (American) or 50 μ sec. time constant.

R-803 ALIGNMENT PROCEDURE

The alignment procedure described in each chart may be performed independently, without affecting the others. Warm up the signal generators for at least 15 minutes to make certain that they are stabilized at their operating temperature particularly generators containing vacuum tubes. Consult the instruction manual supplied with the particular test instrument for specific information concerning connection and operation.

The test equipment listed here is intended only as a guide, but alternate instruments should be of similar quality. The following instruments are required for a complete alignment of the tuner.

1. Measurement instruments and tools

Signal source	1) FM signal generator (FMSG)	Meguro MSG-285A or equivalent	
	2) Sweep generator (SWG)	JRC NJM-5217C or equivalent	
	3) AM signal generator (AMSG)	Meguro MSG-221C or equivalent	
	4) FM stereo modulator (MPX-SG)	Sound technology-1000A or equivalent	
	5) Audio oscillator (AFO)	Oscillation freq. range 10-100,000Hz, calibration error within 0.2%, distortion 0.1%	
	6) AM standard loop antenna	Meguro MLA-1001B or equivalent	
	Output indicator	7) Oscilloscope (CRO)	Iwatsu SS-5057V or equivalent
		8) Distortion meter (HDM)	Shibaden CR-6S or equivalent
		9) AC volt meter (ACVTVM)	Kikusui 164 or equivalent
		10) DC volt meter (DCVTVM)	Kikusui 107A or equivalent
	Tools	11) Hex head alignment tool	
		12) Thin plastic shaft alignment tool	

2. General alignment conditions

- 1) The normal test voltage is within 10% of what is indicated on the receiver with less than 2% harmonic distortion.
- 2) Unless otherwise specified, the normal ambient temperature is 15-25°C and humidity 55-75%. But if this is not possible, 5-35°C, 45-85% will provide acceptable results.
- 3) FM dummy antenna shall be as follows if not otherwise specified. The output voltage of the signal generator is 1/4 of the unloaded terminal voltage.

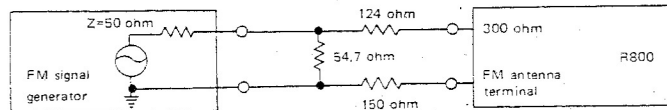

- 4) Connect the low side of signal source and the output indicator to the chassis ground as close as possible to the high side connection unless otherwise specified.
- 5) The 10.7 MHz marker used in each section of the alignment should be the same.
- 6) Marker insertion and amplitude should not distort the oscilloscope trace.
- 7) The AM standard loop antenna should be set above the ferrite loopstick antenna.
- 8) The output level of the sweep generator is measured by the output attenuator regardless of its terminated impedance.
- 9) FM modulation is 100% with ± 75 KHz
- 10) All tuner audio output measurement are at TAPEOUT 1.

SYMBOL NO.	DESCRIPTION	SYMBOL NO.	DESCRIPTION	SYMBOL NO.	DESCRIPTION	SYMBOL NO.	DESCRIPTION
R604	18K	R706	47K	R718	22 1/2W	R728	22 1W
R605	1.5K	R707	8.2K		METAL OXIDE FIXED		METAL OXIDE FIXED
R606	220K	R708	3.3K	R719	32	R801	
R607	3.3K	R709	3.3K	R720	1K	R802	10K
R608	68K	R710	1.5K 1/2W	R721	100K	R803	47 2W
R609	5.6K		METAL OXIDE FIXED	R722	1K		METAL OXIDE FIXED
R610	2.2K	R711	470	R723	82	R804	33
R611	150K	R712	1.2K	R724	100 1/2W	R805	100K
R612	10	R713	47K		METAL OXIDE FIXED	R806	820
		R714	180 1/2W	R725	100 1/2W	R807	4.7 1W
R701	5.6K		METAL OXIDE FIXED		METAL OXIDE FIXED	R808	METAL OXIDE FIXED
R702	47	R715	47 1/2W	R726	0.39 5W		4.7 1W
R703	47		METAL OXIDE FIXED	R727	CEMENT SEALED	R809	METAL OXIDE FIXED
R704	6.8K	R716	5.6K		0.39 5W		4.7 1W
R705	6.8K	R717	3.3K		CEMENT SEALED		METAL OXIDE FIXED

CAPACITORS

SYMBOL NO.	DESCRIPTION	SYMBOL NO.	DESCRIPTION	SYMBOL NO.	DESCRIPTION	SYMBOL NO.	DESCRIPTION
C1	0.1μF 25V +80% -20% ceramic	C10	0.0022μF 250V	C11	4700μF 50V +50% -10% electrolytic	C16	0.01μF 250V
C2	0.1μF 25V +80% -20% ceramic	C11	4700μF 50V +50% -10% electrolytic	C12	4700μF 50V +50% -10% electrolytic	C17	1500μF 50V +50% -10% electrolytic
C3	0.1μF 25V +80% -20% ceramic	C12	0.01μF 250V	C13	0.01μF 250V	C18	3300μF 50V +50% -10% electrolytic
C4	0.1μF 25V +80% -20% ceramic	C13	0.01μF 250V	C14	0.01μF 250V		
C5	0.1μF 25V +80% -20% ceramic	C14	0.01μF 250V	C15	0.01μF 250V		
C6	0.1μF 25V +80% -20% ceramic	C15	0.01μF 250V	C16	0.01μF 250V		
C7	0.022μF 250V	C16	0.01μF 250V	C17	1500μF 50V +50% -10% electrolytic		
C8	0.022μF 250V	C17	1500μF 50V +50% -10% electrolytic	C18	3300μF 50V +50% -10% electrolytic		
C9	0.0022μF 250V	C18	3300μF 50V +50% -10% electrolytic				

SYMBOL NO.	DESCRIPTION	SYMBOL NO.	DESCRIPTION	SYMBOL NO.	DESCRIPTION	SYMBOL NO.	DESCRIPTION
C101	22PF	C106	100PF	C111	1000PF	C116	15PF
C102	47PF	C107	5000PF	C112	5000PF	C117	5000PF
C103	22PF	C108	100PF	C113	1PF	C118	5000PF
C104	22PF	C109	100PF	C114	20PF		
C105	7PF	C110	5000PF	C115	10PF		

SYMBOL NO.	DESCRIPTION	SYMBOL NO.	DESCRIPTION
C201	0.01μF +80% -20% 50V ceramic	C226	0.01μF +80% -20% 50V ceramic
C202	0.04μF +80% -20% 25V ceramic	C227	0.04μF +80% -20% 25V ceramic
C203	0.04μF +80% -20% 25V ceramic	C228	0.01μF +80% -20% 50V ceramic
C204	47PF ±10% 50V ceramic	C229	0.01μF +80% -20% 50V ceramic
C205	0.04μF +80% -20% 25V ceramic	C230	0.47PF ±5% 500V ceramic
C206	0.01μF +80% -20% 50V ceramic	C231	470PF ±20% 50V ceramic
C207	2.7PF ±5% 500V ceramic	C232	0.04μF +80% -20% 25V ceramic
C208	0.04μF +80% -20% 25V ceramic	C233	0.04μF +80% -20% 25V ceramic
C209	470PF ±20% 50V ceramic	C234	0.01μF +80% -20% 50V ceramic
C210	0.04μF +80% -20% 25V ceramic	C235	0.01μF +80% -20% 50V ceramic
C211	0.01μF +80% -20% 50V ceramic	C236	0.1μF +80% -20% 25V ceramic
C212	0.04μF +80% -20% 25V ceramic	C237	2.2μF +75% -10% 50V electrolytic
C213	0.04μF +80% -20% 25V ceramic	C238	0.1μF +80% -20% 25V ceramic
C214	0.04μF +80% -20% 25V ceramic	C239	0.1μF +80% -20% 25V ceramic
C215	0.04μF +80% -20% 25V ceramic	C240	4.7μF +75% -10% 35V electrolytic
C216	0.04μF +80% -20% 25V ceramic	C241	1μF +75% -10% 50V electrolytic
C217	0.04μF +80% -20% 25V ceramic	C242	10μF +50% -10% 16V electrolytic
C218	470P ±20% 50V ceramic	C243	0.1μF +50% -20% 35V solid tantalum
C219	100P ±10% 50V ceramic	C244	4.7μF +75% -10% 35V electrolytic
C220	470P ±20% 50V ceramic	C245	4.7μF +75% -10% 35V electrolytic
C221	470P ±20% 50V ceramic	C246	4.7μF +75% -10% 35V electrolytic
C222	470P ±20% 50V ceramic	C247	470μF +50% -10% 16V electrolytic
C223	0.04μF +80% -20% 25V ceramic	C248	680PF ±5% 50V polystyrol
C224	0.04μF +80% -20% 25V ceramic	C249	1600PF ±5% 50V polystyrol
C225	470P ±20% 50V ceramic	C250	680PF ±5% 50V polystyrol

SYMBOL NO.	DESCRIPTION	SYMBOL NO.	DESCRIPTION
C251	1600PF ±5% 50V polystyrol	C501	0.033μF 50V ±10% mylar
C252	0.22μF +50% -20% 35V solid tantalum	C502	0.068μF 50V ±10% mylar
C253	0.22μF +50% -20% 35V solid tantalum	C503	2700PF 50V ±10% mylar
C254	1μF +75% -10% 50V electrolytic	C504	1500PF 50V ±10% mylar
C255	47μF +50% -10% 16V electrolytic	C505	470PF 50V ±10% ceramic
C256	1μF +75% -10% 50V electrolytic	C506	0.033μF 50V ±10% mylar
C257	2.2μF +75% -10% 50V electrolytic	C507	47μF 10V +50% -10% electrolytic
C258	0.01μF +80% -20% 50V ceramic	C508	2.2μF 25V ±20% solid tantalum
C259	2.2μF +75% -10% 50V electrolytic	C509	10μF 16V +50% -10% electrolytic
C260	560PF ±5% 50V polystyrol	C510	22PF 50V ±10% ceramic
C261	10μF +50% -10% 16V electrolytic	C511	2.2μF 25V ±20% solid tantalum
C262	0.01μF +80% -20% 50V ceramic	C512	220μF 25V +50% -10% electrolytic
C301	0.04μF +80% -20% 25V ceramic	C601	0.027μF 50V ±10% mylar
C302	0.04μF +80% -20% 25V ceramic	C602	1000PF 50V ±10% mylar
C303	2.2μF +75% -10% 50V electrolytic	C603	2700PF 50V ±10% mylar
C304	15PF ±10% 50V ceramic	C604	1000PF 50V ±10% mylar
C305	0.04μF +80% -20% 25V ceramic	C605	4.7μF 10V ±20% solid tantalum
C306	0.04μF +80% -20% 25V ceramic	C606	47μF 6.3V +50% -10% electrolytic
C307	0.04μF +80% -20% 25V ceramic	C607	2.2μF 25V ±20% solid tantalum
C308	0.04μF +80% -20% 25V ceramic	C608	0.04μF 50V +80% -20% ceramic
C309	0.04μF +80% -20% 25V ceramic	C609	47μF 25V +50% -10% electrolytic
C310	2.2μF +75% -10% 50V electrolytic	C701	4.7μF 10V ±20% solid tantalum
C311	0.04μF +80% -20% 25V ceramic	C702	330PF 50V ±10% ceramic
C312	15PF ±10% 50V ceramic	C703	47μF 10V +50% -10% electrolytic
C313	450PF ±5% 50V polystyrol	C704	1000PF 50V ±10% ceramic
C314	0.04μF +80% -20% 25V ceramic	C705	100μF 50V +50% -10% electrolytic
C315	0.01μF +80% -20% 50V ceramic	C706	33μF 10V +50% -10% electrolytic
C316	0.04μF +80% -20% 50V ceramic	C707	47PF 50V ±10% ceramic
C317	0.04μF +80% -20% 25V ceramic	C708	100μF 50V +50% -10% electrolytic
C318	0.04μF +80% -20% 25V ceramic	C709	47μF 50V +50% -10% electrolytic
C319	0.04μF +80% -20% 25V ceramic	C710	0.022μF 50V ±10% mylar
C320	0.01μF +80% -20% 50V ceramic	C711	47PF 50V ±10% ceramic
C321	0.04μF +80% -20% 25V ceramic	C712	0.04μF 50V +80% -20% ceramic
C322	220μF +50% -10% 16V electrolytic	C713	0.022μF 50V ±10% mylar
C323	0.04μF +80% -20% 25V ceramic	C714	0.022μF 50V ±10% mylar
C324	0.04μF +80% -20% 25V ceramic	C715	0.04μF 50V +80% -20% ceramic
C325	220PF ±10% 50V ceramic	C716	1μF 50V +75% -10% electrolytic
C326	4700PF ±10% 50V mylar	C717	0.04μF 50V +80% -20% ceramic
C327	47μF +50% -10% 16V electrolytic	C718	1μF 50V +75% -10% electrolytic
C328	0.04μF +80% -20% 25V ceramic	C801	100PF 50V ±10% ceramic
C329	4700PF ±10% 50V mylar	C802	100μF 50V +50% -10% electrolytic
C330	0.04μF +80% -20% 25V ceramic	C803	220μF 35V +50% -10% electrolytic
C331	220PF ±10% 50V ceramic	C804	330μF 25V +50% -10% electrolytic
C332	1μF +75% -10% 50V electrolytic	C805	
C401	100μF 10V +50% -10% electrolytic	C806	0.1μF 50V ±10% mylar
C402	2.2μF 25V ±20% solid tantalum	C807	0.1μF 50V ±10% mylar
C403	47PF 50V ±10% ceramic	C808	220μF 16V +50% -10% electrolytic
C404	150PF 50V ±10% ceramic		
C405	33PF 50V ±10% ceramic		
C406	33μF 10V +50% -10% electrolytic		
C407	1800PF 50V ±10% mylar		
C408	6800PF 50V ±10% mylar		
C409	22μF 10V +50% -10% electrolytic		
C410	0.04μF 50V +80% -20% ceramic		
C411	0.47μF 35V ±20% solid tantalum		
C412	47μF 10V +50% -10% electrolytic		
C413	2.2μF 25V ±20% solid tantalum		
C414	150PF 50V ±10% ceramic		
C415	33μF 10V +50% -10% electrolytic		
C416	22PF 50V ±10% ceramic		
C417	22μF 10V +50% -10% electrolytic		
C418	2.2μF 35V ±20% solid tantalum		
C419	2.2μF 35V ±20% solid tantalum		
C420	0.47μF 35V ±20% solid tantalum		

Step.	Signal Source Connected to	Set signal to	Set Radio Dial to	Output Indicator Connected to	Adjust	Adjust for
35	Set selector switch to "AM"					
36	Connect CP1 and TP2 on PB458					
37	Sweep generator PB458 34 through 1 μ F mylar capacitor	$\pm 20 \sim 25$ KHz sweep centred at 455KHz generator output level 3mV	Quiet point on band near 1600KHz	Oscilloscope PB458 CP-2	F301 red core F301 blue core	Maximum amplitude. Do not adjust for two humps Symmetrical response with flat top
38						
39						
40	Disconnect CP1 and TP2 connected at step 36					
41	Adjust VR301 to mechanical center position					
42	AM signal generator Standard radiating loop antenna placed near AM built in antenna	600KHz at 400Hz 30% modulation, field strength 50dB/m	600KHz	Oscilloscope AC VTVM TAPE OUT 1	T302 core L1 core T301 core	Accurate indication of pointer on dial to within ± 1 pointer width Maximum reading on AC VTVM
43						
44						
45		1400KHz at 400Hz 30% modulation, field strength 50dB/m	1400KHz		TC3	Accurate indication of pointer on dial to within ± 1 pointer width
46					TC1	Maximum reading on AC VTVM
47					TC2	
48	Repeat steps 42 \sim 47 as necessary to obtain exact tuning on dial scale and maximum sensitivity					
49	AM signal generator Standard radiating loop antenna placed near AM built in antenna	1000KHz at 400Hz 30% modulation, field strength 45dB/m	1000KHz		VR301	Audio output level should be 14dB below what is observed with the field strength of 70dB/m

SEMICONDUCTOR SPECIFIC CHART

TRANSISTORS (Ta = 25°C)

TYPE	MAX. RATING			CHARACTERISTICS											
	Pc W	Vceo V	Ic mA	hfe				fT MHz			NF				
				min	max	Ic mA	Vce V	typ	Ic mA	Vce V	max dB	Ic mA	Vce V	f _{re} Hz	Zg Ω
2SA620K	0.2	70	50	150	320	1	6	120	1	6	0.7	0.1	6	1K	10K
2SA640L	0.25	45	30	225	450	0.5	3	100	1	3					
2SA663Y	60	30	7000	50	120	1000	5	6	1000	5					
2SA733P,Q	0.25	40	100	135	270	1	6	180	10	6	20	0.3	6	100	10K
2SB536L,K	20	120	1500	30	250	300	5	60	100	5					
2SC372Y	0.2	30	100	120	240	2	12	200	1	10					
2SC381R	0.1	30	20	40	80	1	6	350	1	6					
2SC535	0.1	20	20					700	5	6	5.5	1	6	100M	50
2SC735Y	0.3	30	400	120	240	100	1	300	50	5					
2SC793Y	60	80	7000	50	120	1000	5	9	1000	5					
2SC945P,Q	0.25	40	100	135	270	1	6	300	10	6	20	0.5	6	1K	500
2SC959L	0.7	80	700	90	150	200	5	50	150	5					
2SC1000GR	0.2	50	100	200	400	2	6	80	1	6	3	0.1	6	100	10K
2SC1345E	0.2	50	100	400	800	2	12	230	2	12	1	0.1	6	1K	10K
2SD38/L,K	20	120	1500	80	250	300	5	60	100	5					

FIELD EFFECT TRANSISTOR (Ta = 25°C)

TYPE	MAX. RATING			CHARACTERISTICS						
	Pch mW	VG1SS, VG2SS V	IG1, IG2 mA	IDSS mA		Crss pF	NF			
				min	max		Vds V	Vds V	typ	Vds V
3SK30	200	-15	10	3	20	10	0.6	10	2.0	10
2SK19	200	-18	10	3	24	10	0.8	10	2.0	10

DIODES (Ta = 25°C)

TYPE	MAX. RATING			CHARACTERISTICS			
	IF A	Vr V	Surge A	If		Ir	
				mA	Vf V	μA	Vr V
IS188	0.05	-35	0.5	0.004	0.1	-75	-10
IS1554	0.3	-50	1	100	1.0	0.5	-50
KB265	0.03			0.003	1.31		
SV-03	0.15			1	1.8	10	-100
WZ-120	0.04	-12		20	0.8	0 ~ 40mA	-12
CZ-117	0.085	-11.7		20	0.85	0 ~ 85mA	-11.7
IN4003	1	-200	30	1000	1.1	5	-200
HI-FI SPECIAL	3	-400	150	3000	1.25	5	-400

INTEGRATED CIRCUIT SPECIFIC CHART

TA7061AP

MAXIMUM LIMITS OF DEVICE (Ta = 25°C)

	Symbol	Rating	Unit
Max. Vcc	Vcc	15	V
Input voltage (terminals 6-7)	V _I	±3	V
Max. dissipation	PD	300	mW
Operating temperature (Vcc = 7.5V)	T _{opr}	-30~75	°C
Storage temperature	T _{stg}	-55~125	°C

ELECTRICAL SPECIFICATION (Ta = 25°C)

	Symbol	Condition of measurement	Min.	Typ.	Max.	Unit
Current vs supply Vcc	I _{cc}	Vcc = 6.0V		11	13	mA
		Vcc = 7.5V	7	8.5		
Gain (dB)	G _p	Vcc = 7.5V, f = 10.7MHz	66	69	72	dB
Input impedance	R _I	Vcc = 7.5V, f = 10.7MHz		5		KΩ
Input capacitance	C _I			6		pF
Output impedance	R _O	Vcc = 7.5V, f = 10.7MHz		10		KΩ
Output capacitance	C _O			5		pF
Input voltage for full limiting	V _I (lim)	Vcc = 7.5V, R _L = 1KΩ	600			μV

EQUIVALENT CIRCUIT

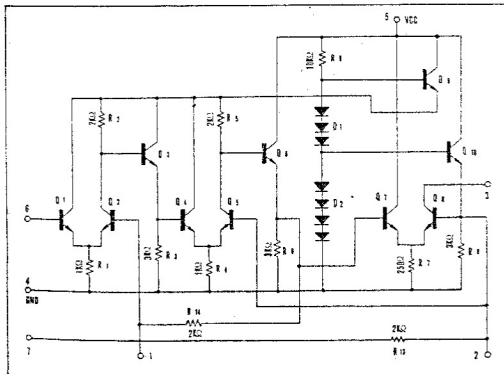

PIN CONNECTOR

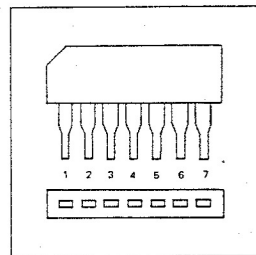

μPC555A

MAXIMUM LIMITS OF DEVICE (Ta = 25°C)

	Symbol	Rating	Unit
Max. supply voltage	V _{cc}	20	V
Output collector voltage	V ₇	24	V
Input voltage	V ₃₋₅	±5.0	V
Max. dissipation	PD	200	mW
Operating temperature	T _a	-55 ~ +125	°C
Storage temperature	T _{stg}	-65 ~ +150	°C

ELECTRICAL SPECIFICATION (Ta = 25°C Vcc = 12V)

	Symbol	Condition of measurement	Min.	Typ.	Max.	Unit
Power dissipation	PD	e _{in} = 0		110	170	mW
Output collector current	I ₇	e _{in} = 0	1.9	2.5	3.1	mA
Peak to peak current	i _{opp}	e _{in} = 400mVrms f ≤ 1KHz	3.6			mA P.P
Output saturation	V _{o(SAT)}				1.7	V
Forward transfer admittance		e _{in} = 10mV rms f ≤ 1KHz	29	35		mV
Input conductance	g _{in}	e _{in} ≤ 10mV rms f ≤ 5MHz		0.30	0.43	mV
Input capacitance	c _{in}	e _{in} ≤ 10mV rms f ≤ 5MHz			16	PF
Output capacitance	C _o	f ≤ 5MHz		2.0	3.0	PF
Output conductance	g _o	e _o ≤ 10mV rms f ≤ 5MHz		0.015	0.04	mV
Voltage gain	G _v	f = 10.7MHz R _L = 1KΩ R _{in} = 50Ω		31		dB

EQUIVALENT CIRCUIT

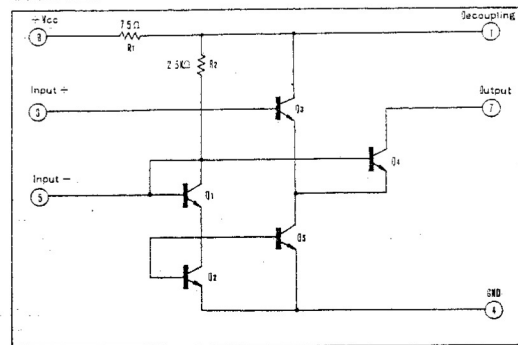

PIN CONNECTOR (Top view)

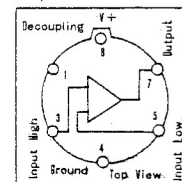

μPC554C

ABSOLUTE MAXIMUM RATING (Ta = 25°C)

	Symbol	Rating	Unit
Supply voltage	Vcc	15	V
Max. device current	Icc	18	mA
Lamp driver current, max.	IL	100	mA
Device dissipation, max.	PD	400	mW
Operating temperature	Topr	0~±75	°C
Storage temperature	Tstg	40~±125	°C

Note

1. Condition of measurement = input signal 200mVrms (Pilot 10%), frequency 1KHz.
2. R.P.F. of f = 15KHz shall be used for separation measurement.

ELECTRICAL CHARACTERISTICS (Ta = 25°C, Vcc = +9.0V)

	Symbol	Circuit for measurement	Condition of measurement	Min.	Typ.	Max.	Unit
Circuit current	Icc	1	at zero signal		10	18	mA
Input impedance	Zi	1			20		KΩ
Separation			f = 100Hz		35		dB
			f = 1KHz		45		
			f = 10KHz		30		
Gain (dB)	Av	1	38KHz B.E.F.		-1.5		dB
Channel balance	ch. B	1	(Mono)		0.2	2.0	dB
Distortion	T.H.D.		(Mono)		0.5	1.0	%
Audio / muting changeover level	Mute OFF	1			0.85	1.00	V
	Mute ON	1		1.00	1.08		
Sensitivity of Stereo indicator lamp	Lamp ON	1	(Pilot level)		12		mV
	Lamp OFF	1			8.4		
Stereo / mono Changeover level	STEREO	1		1.00	1.13		V
	MONO	1			0.82	1.00	
AM suppression	19KHz		(within 1KHz)		30		dB
	38KHz				25		
SCA rejection	SCA Rejection				55		dB
Muting		1		45	55		dB

EQUIVALENT CIRCUIT

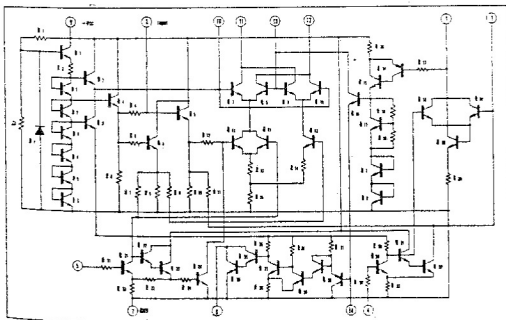

PIN CONNECTOR (Top view)

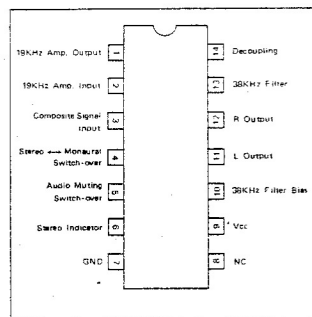

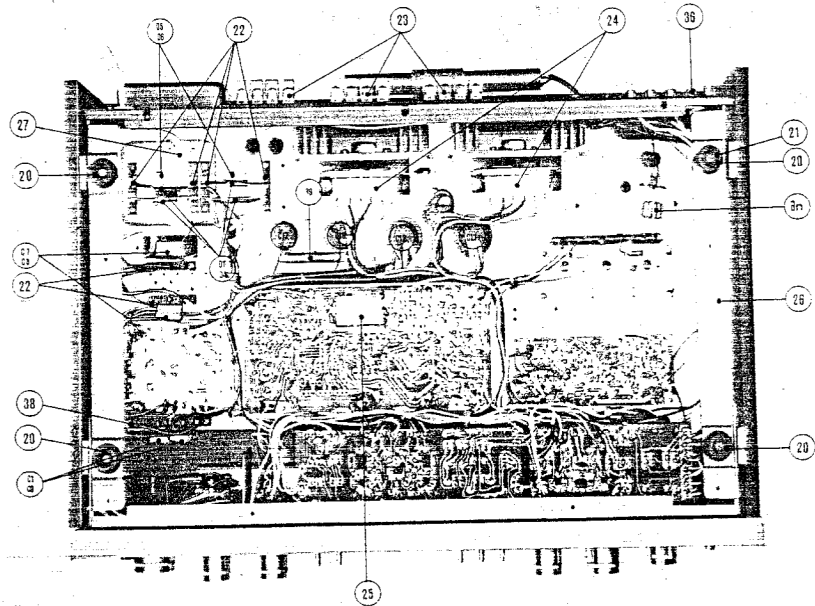
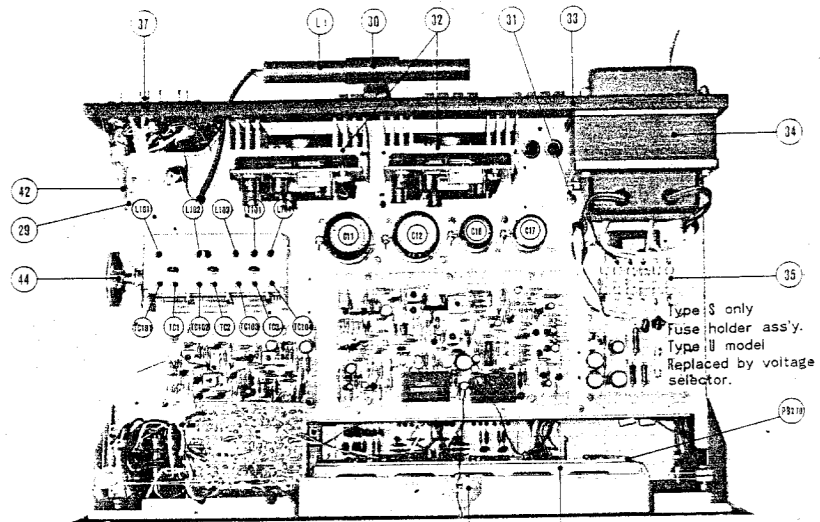

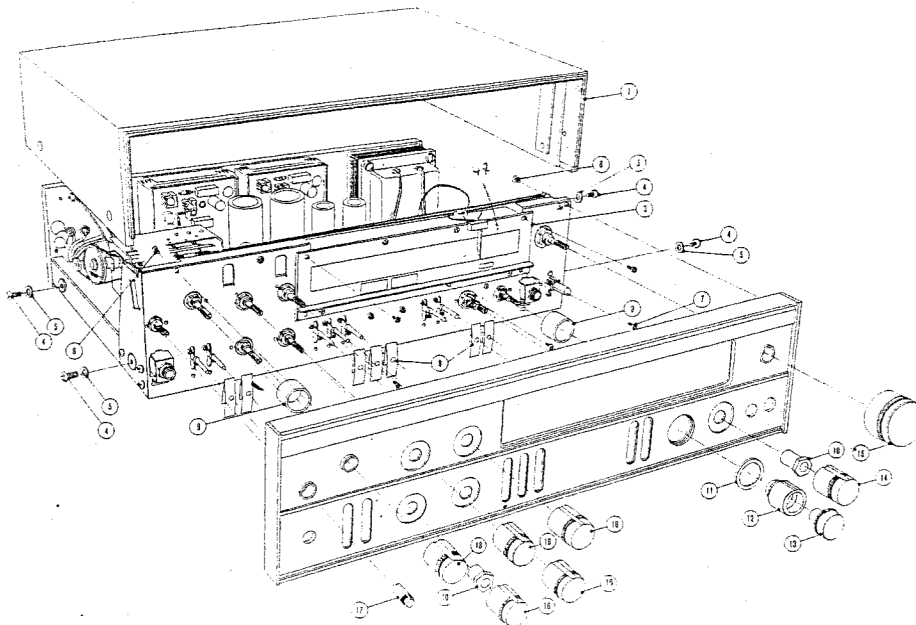

1. Cover (Wood Finish, ex. Rose wood)
2. Panel (Front complete Ass'y)
3. Dial Scale
4. Screw 5mm x 18mm
5. Washer, Nylon
6. Screw 4mm x 6mm
7. Screw 3mm x 8mm
8. Mask, paper (Switch)
9. Bush, mounting
10. Collet Nut
11. Ring
12. Knob (outer volume)
13. Knob (inner volume)
14. Knob (speaker selector)
15. Knob (Tuning)
16. Knob (Tone control and selector)
17. Knob (Mic. Level)
- Bn Antenna Balun
20. Rubber Foot.
21. Screw 3 mm x 10mm
22. Stand off Insulator (3 bugs)
23. Speaker Terminal Ass'y (3 per Set)
24. Connector, Female, Ass'y.
25. Shield I.F.
26. Chassis Complete Ass'y.
27. Clamp, Cable
28. Housing, Pilot lamp
29. Bracket, Pulley

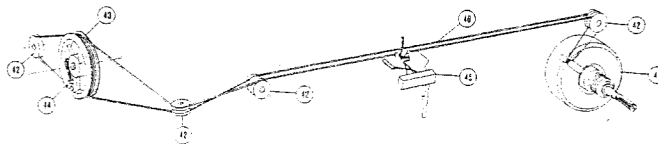

30. Bracket, Antenna
31. Bracket, Transformer x 2
32. Power Amp. Complete Ass'y.
33. Panel Back
34. Power Trans = P-1847 U.S.A. & GENERAL EUROPE
P-1837 Scandinavia
35. Type S model only Fuse Hold b section 20 x 5 mm
Type U.E. and Model Replaced by Voltage selector
36. Pin Jack Ass'y. Female
37. Antenna Terminal Ass'y.
38. Stand off Insulator (S lugs)
41. Tuning shaft and flywheel assy complete with mounting collet
42. Pulley (4.2mm x 13mm)
43. Drum (Tuning Capacitor)
44. Spring (tension for dial cord)
45. Tuning Pointer Ass'y (complete with lamps) → BX 0008
46. Cord, Dial (approx length 108 metre)
47. Pilot Lamp AL 0014

Volume, Variable Resistor: RV 0013 200k 2 B x 2

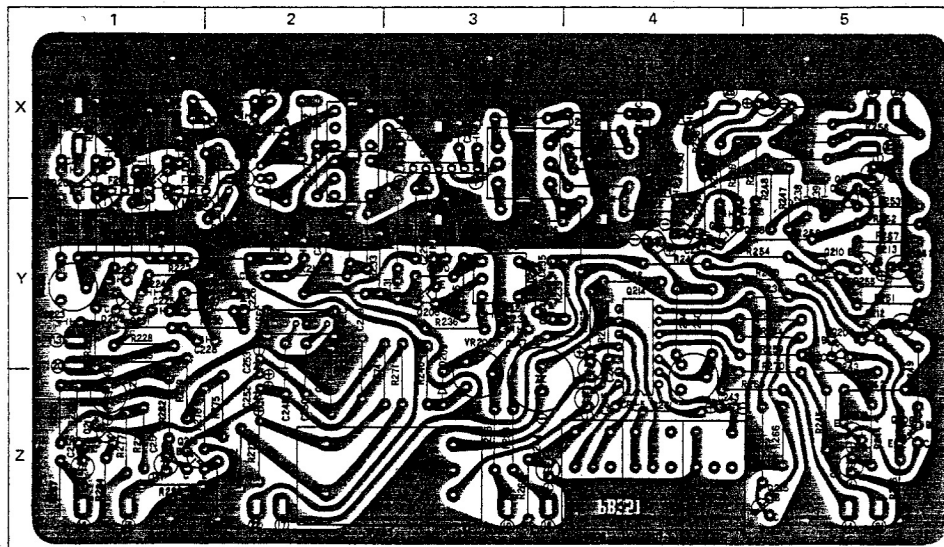

PB-351 Component Location

R201	Y1	R234	Y3	R267	Z5	C201	X1	C234	Y3	VR201	Y1
R202	X1	R235	Y3	R268	Y4	C202	X1	C235	Y3	VR202	Y3
R203	X1	R236	Y3	R269	Z5	C203	X1	C236	Y5	VR203	Y4
R204	Y1	R237	Y3	R270	Y5	C204	X1	C237	Z5		
R205	Y1	R238	Z3	R271	Z3	C205	Y2	C238	Z5	Q201	X1
R206	Y1	R239	Y4	R272	Z2	C206	X2	C239	Y5	Q202	X1
R207	X1	R240	Z3	R273	Z2	C207	X2	C240	Y5	Q203	X2
R208	X1	R241	Y4	R274	Z3	C208	X2	C241	X5	Q204	X3
R209	Y1	R242	Z5	R275	Z2	C209	Y2	C242	Y5	Q205	Y1
R210	X2	R243	Z5	R276	Z1	C210	X3	C243	Z4	Q206	Y3
R211	Y2	R244	Z5	R277	Z1	C211	Y2	C244	Z3	Q207	Y5
R212	X2	R245	Z5	R278	Z1	C212	X3	C245	Z4	Q208	Z5
R213	Y2	R246	Z5	R279	Z1	C213	X3	C246	Y4	Q209	Z5
R214	X2	R247	Y5	R280	Z1	C214	Y3	C247	Z3	Q210	Y5
R215	X3	R248	Y5	R281	Z2	C215	Y3	C248	Z2	Q211	Y5
R216	Y2	R249	Z5	R282	Z1	C216	Y2	C249	Y2	Q212	Y5
R217	Y3	R250	Y5	R283	Z1	C217	Y2	C250	Z2	Q213	Y5
R218	X4	R251	Y5	R284	Z1	C218	Y4	C251	Z2	Q214	Y4
R219	X4	R252	Y5	R285	Y1	C219	X4	C252	Z2	Q215	Z5
R220	X4	R253	Y5	R286	Z1	C220	X4	C253	Y2	Q216	Z1
R221	X4	R254	Y5	R287	Z1	C221	X4	C254	Z1	Q217	Z1
R222	Y4	R255	Y5	R288	Z3	C222	Y1	C255	Z1	Q218	Y4
R223	X4	R256	Y5	R289	X1	C223	Y1	C256	Z1		
R224	X4	R257	Y5	R290	X4	C224	Y1	C257	Y4	D201	X1
R225	Y1	R258	X5	R291	X4	C225	Y1	C258	Y4	D202	X2
R226	Y1	R259	Y5	R292	X5	C226	Y2	C259	Y4	D203	Y2
R227	Y1	R260	Z3	R293	X5	C227	Y1	C260	Y4	D204	X3
R228	Y1	R261	Z4	R294	Y4	C228	Y1	C261	X5	D205	X4
R229	Y1	R262	Y4	R295	X5	C229	Y3	C262	X4	D206	Y2
R230	Y2	R263	Y4	R296	X4	C230	Y3			D207	Y2
R231	Y1	R264	Y5	R297	Y4	C231	Y3			D208	Y3
R232	Y2	R265	Y5	R298	X4	C232	Y3			D209	Z3
R233	Y2	R266	Z5			C233	Y3			D210	X5

PB-840

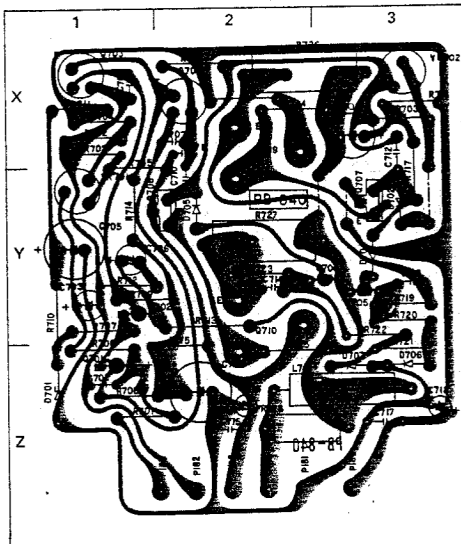

PB-840 Component Location

R701	Z1	C701	Z1	D701	Z1
R702	X1	C702	Z1	D702	Y3
R703	X1	C703	Y1	D703	X3
R704	X1	C704	X1	D704	Y3
R705	X1	C705	Y1	D705	Y2
R706	Z1	C706	Y1	D706	Z3
R707	Y1	C707	X2	D707	Z3
R708	Z1	C708	Z2			
R709	Y1	C709	X3	L701	Z3
R710	Y1	C710	Y2	VR701	Y1
R711	X1	C711	X2	VR702	X3
R712	Y1	C712	X3			
R713	Y2	C713	Y3	P180	Z3
R714	Y1	C714	Y2	P181	Z2
R715	Z2	C715	Z2	P182	Z2
R716	X3	C716	Z2	P183	Z2
R717	X3	C717	Z3	P184	Z2
R718	X2	C718	Z3	P185	Z1
R719	Y3						
R720	Y3	Q701	Z1			
R721	Z3	Q702	Y1			
R722	Z3	Q703	X1			
R723	Y2	Q704	X2			
R724	X2	Q705	Y3			
R725	Z2	Q706	Y3			
R726	X2	Q707	Y3			
R727	Y2	Q708	Y2			
R728	Z2	Q709	X2			
			Q710	Y2			

PB-841

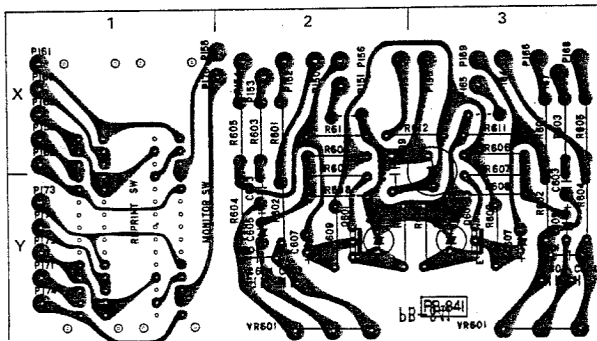

PB-841 Component Location

R601	X3, X2	P150	X2
R602	Y3, Y2	P151	X2
R603	X3, X2	P152	X2
R604	Y3, Y2	P153	X2
R605	X3, X2	P154	X2
R606	X3, X2	P155	X3
R607	X3, X2	P156	X2
R608	Y3, Y2	P157	X2
R609	Y3, Y2	P158	X1
R610	Y3, Y2	P159	X1
R611	X3, X2	P160	X1
R612	X3	P161	X1
			P162	X1
C601	Y3, Y2	P163	X1
C602	Y3, Y2	P164	X3
C603	Y3, Y2	P165	X3
C604	Y3, Y2	P166	X3
C605	Y3, Y2	P167	X3
C606	Y3, Y2	P168	X3
C607	Y3, Y2	P169	X3
C608	X2	P170	X1
C609	X3	P171	Y1
			P172	Y1
Q601	Y3, Y2	P173	Y1
VR601	Y3, Y2	P174	Y1
			P175	Y1
			REPRINT SW	Y1
			MONITOR SW	Y1

PB-842

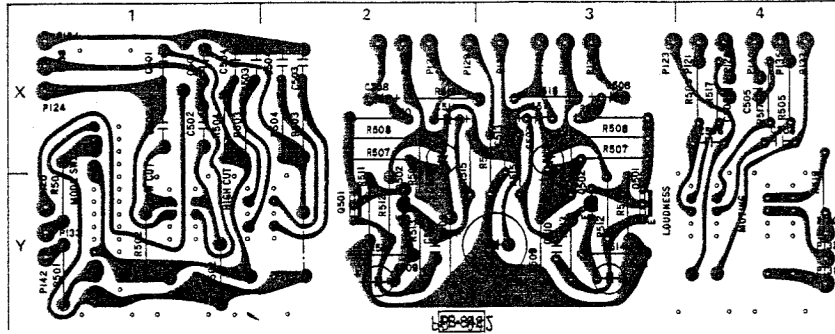

PB-842 Component Location

R501 Y1	R514 Y2, Y3	C507 X2, X3	MUTING SW Y4	P131 Y4
R502 Y1	R515 X2, X3	C508 X2, X3		P132 Y4
R503 X2, X1	R516 X2, X3	C509 Y2, Y3	P120 Y1	P133 Y1
R504 X2, X1	R517 X4	C510 Y2, Y3	P121 X4	P134 X1
R505 X4	R518 X3	C511 X2, X3	P122 X2	P135 X4
R506 X2, X3	R519 Y4	C512 Y3	P123 X3	P136 X3
R507 X2, X3		C513 X3	P124 X1	P137 X4
R508 X2, X3	C501 X1		P125 X2	P138 X1
R509 Y2, Y3	C502 X1	Q501 Y2, Y3	P126 X4	P139 X3
R510 X2, X3	C503 X1, X2	Q502 Y2, Y3	P127 X3	P140 X4
R511 X2, X3	C504 X1, X2		P128 X2	P141 X3
R512 Y2, Y3	C505 X4	LOW CUT SW ... Y1	P129 X2	P142 Y1
R513 Y2, Y3	C506 X3	HIGH CUT SW ... Y1	P130 Y4	

PB-843

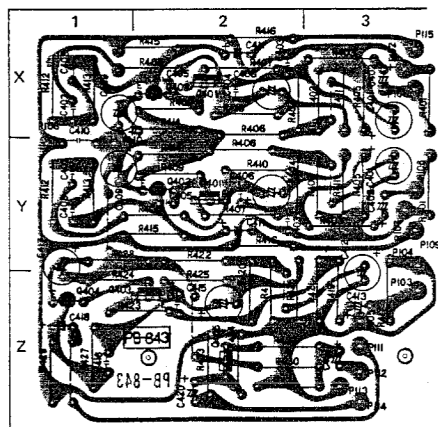

PB-843 Component Location

R401 X3, Y3	R433 Z2	P103 Z3
R402 X3, Y3	R434 Z2	P104 Y3
R403 X3, Y3		P105 Z3
R404 X2, Y3	C401 X3, Y3	P106 Y3
R405 X3, Y3	C402 X3, Y3	P107 Y3
R406 X2, Y2	C403 X2, Y2	P108 Y1
R407 X2, Y2	C404 X2, Y2	P109 Y3
R408 X2, Y2	C405 X2, Y2	P110 Y1
R409 X2, Y2	C406 X2, Y2	P111 Z3
R410 X2, Y2	C407 X1, Y1	P112 Z3
R411 X3, Y3	C408 X1, Y1	P113 Z3
R412 X1, Y1	C409 X1, Y1	P114 Z3
R413 X1, Y1	C410 Y1	P115 X3
R414 X2, Y2	C411 X2, Y2	
R415 X2, Y2	C412 Y3	
R416 X2, Y2	C413 Z3	
R417 Z3	C414 Z2	
R418 Z2	C415 Z2	
R419 Z3	C416 Z1	
R420 Z2	C417 Y1	
R421 Z3	C418 Z1	
R422 Y2	C419 Z3	
R423 Z1	C420 Z2	
R424 Z1		
R425 Z2	Q401 X2, Y2	
R426 Z2	Q402 X2, Y2	
R427 Z1	Q403 Z2	
R428 Y1	Q404 Z1	
R429 Z1	Q405 Z2	
R430 Z2		
R431 Z2	P101 X3	
R432 Z2	P102 X3	

REPLACEMENT PARTS

RESISTORS: $\pm 10\%$ $\frac{1}{4}$ watt deposited carbon, unless noted otherwise

SYMBOL NO.	DESCRIPTION	SYMBOL NO.	DESCRIPTION	SYMBOL NO.	DESCRIPTION	SYMBOL NO.	DESCRIPTION
R1	8.2K	R236	1K	R300	150 Ω	R410	27K
R2	33K	R237	1K	R301	560 Ω	R411	LOW NOISE
R3	33K	R238	10 Ω	R302	$\frac{1}{2}$ W 390 Ω	R412	820
R4	8.2K	R239	1K	R303	10K	R413	LOW NOISE
R5	180K	R240	1.8K	R304	560 Ω	R414	39K
R6	180K	R241	47K	R305	8.2K	R415	LOW NOISE
R7	180K	R242	22 Ω	R306	22K	R416	470K
R8	180K	R243	33K	R307	12K	R417	LOW NOISE
R9	150 - 5W METAL OXIDE FIXED	R244	33K	R308	1K	R418	1.5K
R10	680 - 1W METAL OXIDE FIXED	R245	6.8K	R309	2.2K	R419	10K
R11	680 - 1W METAL OXIDE FIXED	R246	220 Ω	R310	12K	R420	150K
		R247	100K	R311	2.2K	R421	82K
		R248	100K	R312	4.7K	R422	LOW NOISE
		R249	47K	R313	22 Ω	R423	22K
		R250	12K	R314	68K	R424	LOW NOISE
R101	100K	R251	39 Ω	R315	560 Ω	R425	3.9K
R102	22 Ω	R252	39 Ω	R316	4.7K	R426	LOW NOISE
R103	22K	R253	47K	R317	220 Ω	R427	560K
R104	4.7K	R254	47K	R318	560 Ω	R428	LOW NOISE
R105	1K	R255	2.7K	R319	100 Ω	R429	820K
R106	220 Ω	R256	2.7K	R320	10K	R430	LOW NOISE
R107	1M	R257	39K	R321	47K	R431	120K
R108	100 Ω	R258	$\frac{1}{2}$ W 2.2K	R322	15K	R432	180
R109	10K	R259	100K	R323	470 Ω	R433	LOW NOISE
R110	10K	R260	4.7K	R324	8.2K	R434	47K
R111	100 Ω	R261	47 Ω	R325	4.7K	R435	LOW NOISE
R112	3.3K	R262	3.9K	R326	3.3K	R436	12K
		R263	3.9K	R327	22K	R437	LOW NOISE
		R264	10 Ω	R328	3.9K	R438	270
R201	1.8K	R265	15K	R329	150 Ω	R439	LOW NOISE
R202	560 Ω	R266	15K	R330	33K	R440	110K
R203	1K	R267	$\frac{1}{2}$ W 390 Ω	R331		R441	LOW NOISE
R204	470 Ω	R268	100 Ω	R332	100 Ω	R442	3.3K
R205	1.5K	R269	39K	R333	100 Ω	R443	33K
R206	2.2K	R270	100K	R334	10K	R444	470K
R207	680 Ω	R271	36K	R335	100 Ω	R445	680K
R208	1K	R272	3.3K	R336	220 Ω	R446	4.7K
R209	470 Ω	R273	3.3K	R337	2.2K	R447	150K
R210	560 Ω	R274	36K	R338	2.7K	R448	10K
R211	470 Ω	R275	150K	R339	470K		
R212	22K	R276	18K	R340	4.7K	R501	10K
R213	470 Ω	R277	18K	R341	$\frac{1}{2}$ W 680 Ω	R502	1M
R214	470 Ω	R278	150K	R342	4.7K	R503	1M
R215	2.2K	R279	100K	R343	33 Ω	R504	1M
R216	47K	R280	100K			R505	12K
R217	390 Ω	R281	1.2K			R506	22K
R218	1K	R282	10K	R401	68K	R507	470K
R219	1K	R283	10K		LOW NOISE	R508	680K
R220	1K	R284	1.2K	R402	22K	R509	68K
R221	47 Ω	R285	470 Ω		LOW NOISE	R510	4.7K
R222	100 Ω	R286	470K	R403	3.9K	R511	82K
R223	6.8K	R287	470K		LOW NOISE	R512	6.8K
R224	6.8K	R288	3.9K	R404	680K	R513	22K
R225	22K	R289	10K		LOW NOISE	R514	1K
R226	3.3K	R290	33K	R405	1M	R515	5.6K
R227	1K	R291	1M		LOW NOISE	R516	150K
R228	4.7K	R292	47K	R406	120K	R517	27K
R229	1K	R293	100K		LOW NOISE	R518	100
R230	10K	R294	8.2K	R407	180	R519	6.8K
R231	100K	R295	100K		LOW NOISE		
R232	15K	R296	220K	R408	470		
R233	2.2K	R297	220K		LOW NOISE	R601	1.5K
R234	1K	R298	33K	R409	47K	R602	18K
R235	15K				LOW NOISE	R603	2.2K

Step	Signal Source Connected to	Set signal to	Set Radio Dial to	Output Indicator Connected to	Adjust	Adjust for
1		Set selector switch to "FM", muting switch to "off", and turn power switch "on".		DC VTVM PB351 (17)		Check that voltage is between 11.5 ~ 12.3V
2				Refer circuit diagram		Check each part voltage is necessary.
3	Sweep generator PB351 (11)	+400KHz sweep centred at 10.7MHz generator output level 50-100dB	Outlet point on band	Oscilloscope PB351 CP-2		Due to the fixed frequency of the ceramic filters, find the centre frequency of a symmetrical band pass response. Make a note of it for example 10.75MHz
4				Oscilloscope PB351 CP-3	T201 T202 core	Symmetrical response centred at the frequency noted by step 4
5				Oscilloscope PB351 CP-4	T204 core	
6				Oscilloscope PB351 (23)	T203 top core T203 bottom core	Maximum linearity and amplitude of "S" curve centred at the frequency noted by step 4
7	FM signal generator Across FM antenna terminals (300Ω) through matching network	Reduce the output level to zero (interstation receiving condition) 93MHz at 400Hz 100% modulation, output level 1mV	93MHz	Oscilloscope Distortion meter AC VTVM TAPEOUT 1	T203 top core	Centre indication of the tuning meter
8					T203 bottom core	Minimum distortion. At the minimum distortion setting, the output level must be within 1/2dB of peak output.
9						
10						Repeat steps 8 and 9 as necessary to obtain maximum output level and minimum distortion at centre point of tuning meter and the meter must also show centre at interstation state.
11	FM signal generator Across FM antenna terminals (300Ω) through matching network	88MHz at 400Hz 100% modulation, generator output level 1mV	88MHz	Oscilloscope Distortion meter AC VTVM TAPE OUT 1	T204 core	The signal strength meter must indicate its maximum, at the same time as the centre tune meter indicates centre
12					L104	Accurate indication of pointer on dial to within ± 1 pointer width
13		108MHz at 400Hz 100% modulation, generator output level 1mV	108MHz		TC104	
14		88MHz at 400Hz 100% modulation, generator output level 5 ~ 10μV	88MHz		T101 top core T101 bottom core	Maximum indication of signal strength meter
15					L101	

Step.	Signal Source Connected to	Set signal to	Set Radio Dial to	Output Indicator Connected to	Adjust	Adjust for
16	FM signal generator Across FM antenna terminals (300Ω) through matching network	88MHz at 400Hz 100% modulation, generator output level 5 ~ 10μV 108MHz at 400Hz 100% modulation, generator output level 5 ~ 10μV	88MHz 108MHz	Oscilloscope Distortion meter AC VTVM TAPE OUT 1	L102 L103 TC101 TC102 TC103	Maximum indication of signal strength meter
17						
18						
19						
20	Repeat steps 11 ~ 20 as necessary to obtain correct tuning on dial scale and the maximum indication of signal meter with uniform sensitivity throughout the band					
21	FM signal generator Across FM antenna terminals (300Ω) through matching network	Reduce the output level to zero (interstation receiving condition) 93MHz at 400Hz 100% modulation, output level 1mV 88MHz at 400Hz 100% modulation 108MHz at 400Hz 100% modulation 98MHz at 400Hz 100% modulation output level 7μV	93MHz 88MHz 108MHz 98MHz	Oscilloscope Distortion meter AC VTVM TAPE OUT 1	T203 top core T203 bottom core VR201	Center indication of the tuning meter Minimum distortion. At the minimum distortion setting, the output level must be within 1/2 dB of peak output. IHF maximum usable sensitivity which is the minimum output level of FMSS required for distortion and noise to be -30dB of total output Swing of signal strength meter to first indicator mark or if not possible ± 1/2 is acceptable
22						
23						
24						
25	Repeat steps 21 ~ 26 as necessary to obtain correct tuning on dial scale and the maximum indication of signal meter with uniform sensitivity throughout the band					
26	FM signal generator Across FM antenna terminals (300Ω) through matching network	98MHz at 400Hz 100% modulation, generator output level 7μV 98MHz at 19KHz 3 ~ 4% modulation generator output level 1mV	98MHz	Oscilloscope AC VTVM TAPE OUT 1 Oscilloscope PB351 CH-5	VR202 T205 core T207 core T206 core	Fix VR202 at the point where output signals appear (muting adjustment) Maximum amplitude of oscilloscope trace
27						
28						
29						
30	Repeat steps 27 ~ 31 as necessary for alignment of perfect tuning					
31	FM signal generator Across FM antenna terminals (300Ω) through matching network	98MHz at 19KHz 10% (L-R) 400Hz 45% output level 1mV 98MHz at 19KHz 10% L (or R) stereo 90% modulation output level 1mV	98MHz	Oscilloscope AC VTVM TAPE OUT 1	T206 core VR203	To obtain peak output voltage Maximum separation
32						
33						
34						

TRANSISTORS & IC

SYMBOL NO.	DESCRIPTION	SYMBOL NO.	DESCRIPTION		
Q101	FM RF AMPLIFIER	3SK30	Q401	PHONO AMPLIFIER	2SC1345
Q102	FM MIXER	2SC535	Q402	PHONO AMPLIFIER	2SA640
Q103	FM LOCAL OSCILATOR	5E3001	Q403	MIC AMPLIFIER	2SC1345
Q201	FM IF AMPLIFIER	2SC381	Q404	MIC AMPLIFIER	2SA640
Q202	FM IF AMPLIFIER	2SC381	Q405	EMITTER FOLLOWER	2SC1345
Q203	FM IF AMP & LIMITTER	μPC555A	Q501	A.F. AMPLIFIER	2SC1345
Q204	FM LIMITTER	TA7061AP	Q502	A.F. AMPLIFIER	2SA640
Q205	FM AGC AMPLIFIER	2SC381	Q601	TONE AMPLIFIER	2SC1345
Q206	FM SIGNAL METER AMPLIFIER	2SC381	Q701	POWER AMPLIFIER	2SA620
Q207	FM MUTING DC AMPLIFIER	2SC372	Q702	POWER AMPLIFIER	2SA620
Q208	WIRED OR GATE FOR FM MUTING	2SC372	Q703	POWER AMPLIFIER	2SC959
Q209	WIRED OR GATE FOR FM MUTING	2SC372	Q704	POWER AMPLIFIER	2SC959
Q210	FM MUTING DC AMPLIFIER	2SC1000	Q705	POWER AMPLIFIER	2SC945
Q211	FM MUTING DC AMPLIFIER	2SA640	Q706	POWER AMPLIFIER	2SA733
Q212	FM MUTING DC AMPLIFIER	2SC372	Q707	POWER AMPLIFIER	2SD381
Q213	FM MUTING DC AMPLIFIER	2SC372	Q708	POWER AMPLIFIER	2SB536
Q214	FM STEREO DEMODULATOR	μPC554C	Q709	POWER AMPLIFIER	2SC793
Q215	ACTIVE DUMMY LOAD	2SC735	Q710	POWER AMPLIFIER	2SA663
Q216	FM AUDIO AMPLIFIER	2SC1000	Q801	POWER SUPPLY	2SC1345
Q217	FM AUDIO AMPLIFIER	2SC1000			
Q218	FM MUTING	2SK30			
Q301	AM RF AMPLIFIER	2SC381			
Q302	AM MIXER & OSCILATOR	2SC372			
Q303	AM IF AMPLIFIER	2SC372			
Q304	AM IF AMPLIFIER	2SC372			

DIODES

SYMBOL NO.	DESCRIPTION	SYMBOL NO.	DESCRIPTION		
D1	RECTIFIER	HIFI SPECIAL	D301	INPUT CLAMP	IS1554
D2	RECTIFIER	HIFI SPECIAL	D302	INPUT CLAMP	IS188
D3	RECTIFIER	HIFI SPECIAL	D303	AGC CONTROL	IS1554
D4	RECTIFIER	HIFI SPECIAL	D304	TEMPERATURE COMPENSATION	KB265
D5	RECTIFIER	1N4003	D305	AGC DETECTOR	IS1554
D6	RECTIFIER	1N4003	D306	AUDIO & METER DETECTOR	IS188
D201	CHECK POINT DETECTOR	IS188	D307	METER PROTECTION	IS188
D202	FM LIMITTER	IS188	D308	AGC DETECTOR	IS188
D203	CHECK POINT DETECTOR	IS188	D701	POWER AMPLIFIER	WZ-120
D204	FM RATIO DETECTOR	IS188	D702	POWER AMPLIFIER	SV-03
D205	FM RATIO DETECTOR	IS188	D703	POWER AMPLIFIER	IS1554
D206	AGC DETECTOR	IS188	D704	POWER AMPLIFIER	IS1554
D207	AGC DETECTOR	IS188	D705	POWER AMPLIFIER	IS1554
D208	FM METER DETECTOR	IS188	D706	POWER AMPLIFIER	IS1554
D209	TEMPERATURE COMPENSATION	KB265	D707	POWER AMPLIFIER	IS1554
D210	VOLTAGE STABILIZER	WZ120	D801	POWER SUPPLY	1N4003
			D802	POWER SUPPLY	CZ-117

VARIABLE RESISTORS

SYMBOL NO.	DESCRIPTION	SYMBOL NO.	DESCRIPTION		
VR1	100K-A (with S7)	FOR MIC MIXING	VR301	330Ω-B SEMI FIXED	FOR AM AGC SETTING
VR2	200K-BX2 with C.T	FOR VOLUME CONT.	VR601	100K-B	FOR TONE CONT.
VR3	50K-B	FOR TONE CONT.	VR701	4.7K-B SEMI FIXED	FOR POWER AMP.
VR201	4.7K-B SEMI FIXED	FOR FM IF GAIN	VR702	330Ω-B SEMI FIXED	FOR POWER AMP.
VR202	470Ω-B SEMI FIXED	FOR FM MUTING LEVEL			
VR203	4.7KΩ-B SEMI FIXED	FOR FM SEPARATION			

SWITCHES

SYMBOL NO.	DESCRIPTION	SYMBOL NO.	DESCRIPTION
S1	4-8-6 ROTARY SW	S8	6-3 LEVER SW
S2	2-3 LEVER SW	S9	6-3 LEVER SW
S3	2-3 LEVER SW	S10	2-4-6 ROTARY SW
S4	2-3 LEVER SW	S11	2-2 LEVER SW
S5	2-2 LEVER SW	S201	2-2 SLIDE SW
S6	6-3 LEVER SW		
S7	(WITH VR1)		
	FUNCTION		MONITOR
	LOW CUT		DUBBING
	HIGH CUT		SPEAKER
	LOUDNESS		POWER
	MUTING		
	MODE		FM DE EMPHASIS
	MIC MIXING		

TRANSFORMERS & FILTERS

SYMBOL NO.	DESCRIPTION	SYMBOL NO.	DESCRIPTION
T101	FM IF TRANS	T302	AM OSCILATOR TRANS
T201	FM IF TRANS	T303	AM IF TRANS
T202	FM IF TRANS	T304	AM IF TRANS
T203	FM DISCRIMINATOR TRANS	F201	FM IF FILTER
T204	FM METER TRANS	F202	FM IF FILTER
T205	19KHz TRANS	F203	FM LOW-PASS FILTER
T206	38KHz TRANS	F301	AM IF FILTER
T207	19KHz TRANS		
T301	AM RF TRANS		
	TKAC-14733K		YXR-18909GN
	TKAC-14733K		101AC-101A
	V4FCC-20693BCV		YMC-15002A
	TKAC-14733K		CF-10M12C
	02-1138		CF-10M12C
	02-1139		LUX-14562
	02-1138		CFT-455B
	YXR-19030BD		

SPECIFICATIONS

AUDIO SECTION

CIRCUIT: Fully complimentary direct coupled D.C. output amp utilizing dual rail power supply

RMS POWER: 40/40Watts (8ohms both channel driven)
45/45Watts (14ohms both channel driven)

T.H.D.: <0.05% (8ohms, 40Watts)
<0.05% (4ohms, 45Watts)

FREQUENCY RESPONSE: 15Hz - 35KHz (-1dB)
5Hz - 75KHz (-3dB)

POWER BANDWIDTH: 5Hz - 40KHz 10.1%, -3dB

INPUT SENSITIVITY: PHONO 1, PHONO 2 2.3mV (at 40Watts, 8ohms)
AUX 1, AUX 2 150mV (at 40Watts, 8ohms)
TAPE MONITOR 1, 2 150mV (at 40Watts, 8ohms)
MIC 2mV (at 40Watts, 8ohms)

REC OUT: RCA type pin-plug 150mV, 100ohms
DIN pin-plug 30mV, 90Kohms
R.I.A.A.

EQUALIZER CURVE: Treble & Bass Lux type NF tone control

PERMISSIBLE PHONO INPUT VOLTAGE: 100mV at 1KHz

TONAL CONTROL: Turnover frequency 3KHz -9.5dB
Bass: 300Hz ±10.5dB
LOW CUT 70Hz, 20Hz -6dB/oct.
HIGH CUT 6KHz, 12KHz 6dB/oct.

FILTER: YES

LOUDNESS CONTROL: YES

SN RATIO: Phono 1, Phono 2 > 66dB MIC 60dB
Aux 1, Aux 2 > 85dB
Monitor > 85dB

RESIDUAL NOISE: <0.8mV; 85dB

ACCESSORIES: Head-phonc Jack, Mode Selector (stereo-rev-mix)
AC outlet, Voltage selector (100, 120, 220, 240V)
Speaker selector (A, B, C, A+B, A+C)
Dual monitor circuit (useful for tape to tape dubbing)
Protection circuit for amp.
Mic Mixing, etc.
De-emphasis switch (50/75usec.) for universal type.

FM SECTION

IHF SENSITIVITY: 1.8µV

SENSITIVITY FOR 50dB S/N: 3.6µV

ULTIMATE S/N: 70dB

THD, Mono: 0.3% (at 400Hz)

Stereo: 0.4% (at 400Hz)

ALTERNATE CHANNEL SELECTIVITY: 70dB

IF REJECTION: 90dB

IMAGE REJECTION: 90dB

SPURIOUS RESPONSE REJECTION: 90dB

AM SUPPRESSION: 55dB

CAPTURE RATIO: 1.3dB

STEREO SEPARATION: (400Hz) 40dB

FROM 100Hz TO 10KHz: 30dB

MUTING THRESHOLD: 7µV

STEREO THRESHOLD: 7µV

FREQUENCY RESPONSE (MONO AND STEREO): 30 to 15,000Hz -0.2dB
-1.5dB

AM SECTION

IHF SENSITIVITY: 14µV

S/N RATIO: 48dB

IF REJECTION: 85dB

IMAGE REJECTION: 72dB

THD: 0.6%

GENERAL SPECIFICATIONS

POWER REQUIREMENTS: 100/120/220/240V 50-60Hz AC

POWER CONSUMPTION: 35-180 W. A.

DIMENSIONS: (W) 480mm (18-1/8") x (D) 360mm
(14-2/16") x (H) 345mm (13-5/8")

W. K. ...

POWER SUPPLY DIAGRAM FOR THE THREE MODELS

(1) SEMODEL ⑤

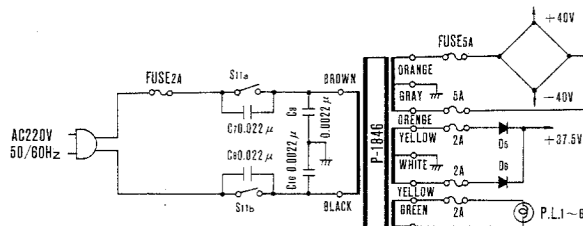

(2) EUROPEAN MODEL ②

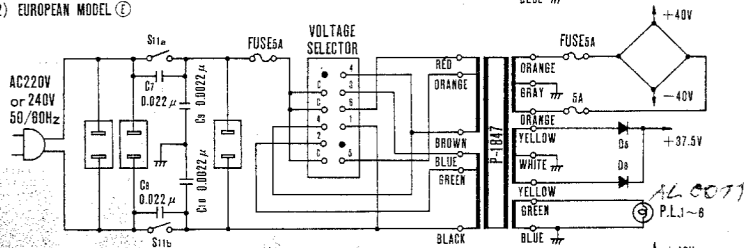

(3) U.S.A. & CANADIAN MODEL ①

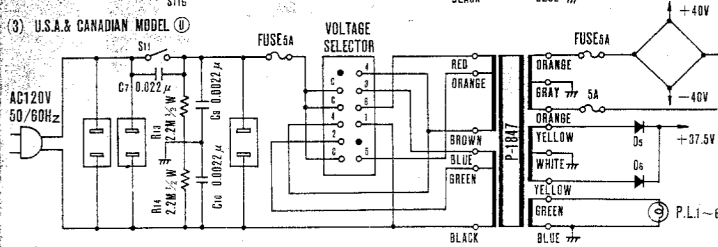

■ AUDIO SECTION

THIS DIAGRAM APPLIES ONLY TO "SEMI" MODELS SHOWN ON REAR PANEL THRU S¹. FOR POWER SUPPLY MODIFICATIONS, PLEASE REFER TO NEXT PAGE FOR EUROPE AND U.S.A. MODELS SHOWN ON REAR PANEL AS S², S³ & S⁴ RESPECTIVELY.

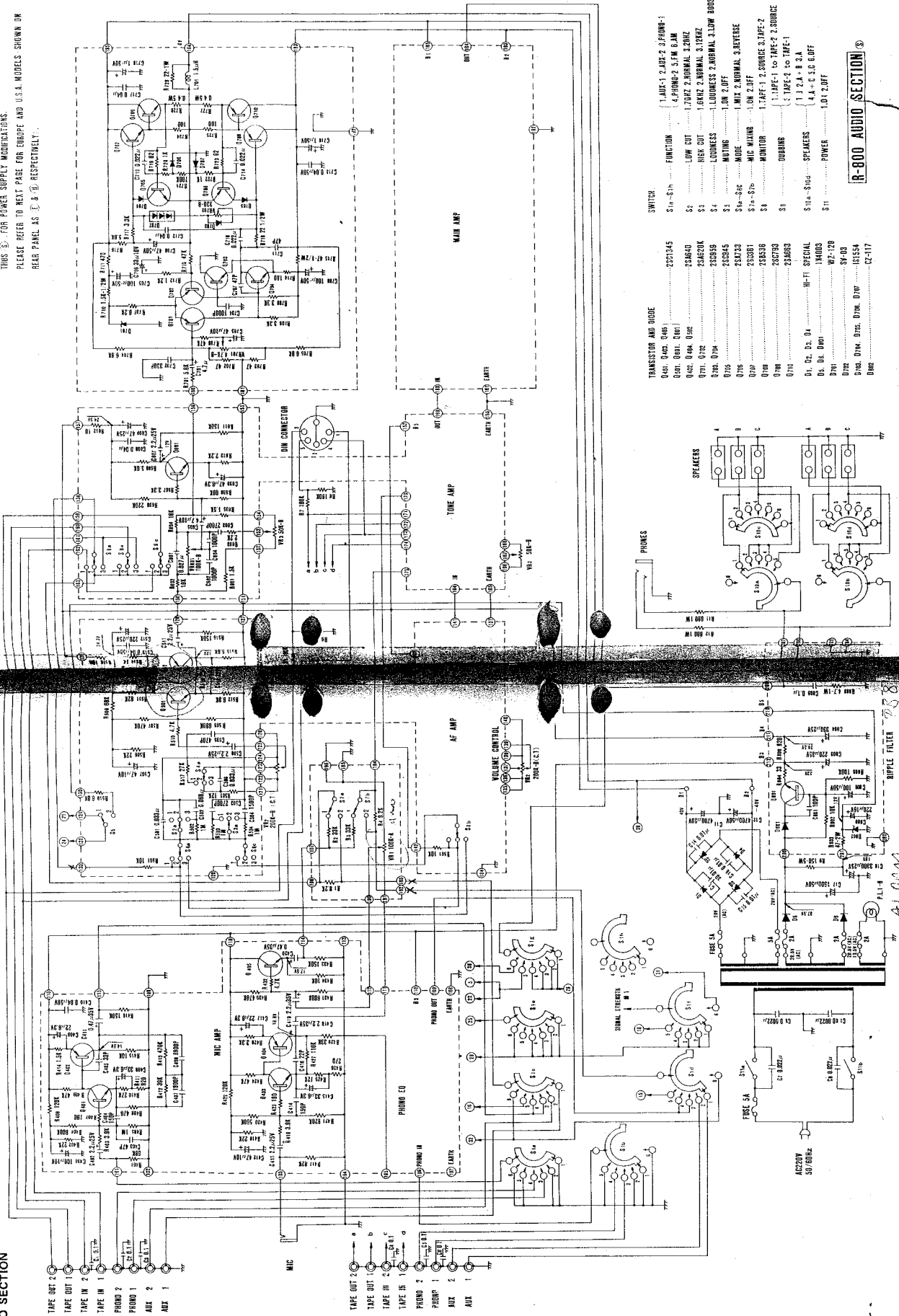

TRANSISTOR AND DIODE	2331345	2331346	2331347	2331348	2331349	2331350	2331351	2331352	2331353	2331354	2331355	2331356	2331357	2331358	2331359	2331360	2331361	2331362	2331363	2331364	2331365	2331366	2331367	2331368	2331369	2331370	2331371	2331372	2331373	2331374	2331375	2331376	2331377	2331378	2331379	2331380	2331381	2331382	2331383	2331384	2331385	2331386	2331387	2331388	2331389	2331390	2331391	2331392	2331393	2331394	2331395	2331396	2331397	2331398	2331399	2331400																																									
Q401	6X4	6X5	6X6	6X7	6X8	6X9	6X10	6X11	6X12	6X13	6X14	6X15	6X16	6X17	6X18	6X19	6X20	6X21	6X22	6X23	6X24	6X25	6X26	6X27	6X28	6X29	6X30	6X31	6X32	6X33	6X34	6X35	6X36	6X37	6X38	6X39	6X40	6X41	6X42	6X43	6X44	6X45	6X46	6X47	6X48	6X49	6X50	6X51	6X52	6X53	6X54	6X55	6X56	6X57	6X58	6X59	6X60	6X61	6X62	6X63	6X64	6X65	6X66	6X67	6X68	6X69	6X70	6X71	6X72	6X73	6X74	6X75	6X76	6X77	6X78	6X79	6X80	6X81	6X82	6X83	6X84	6X85	6X86	6X87	6X88	6X89	6X90	6X91	6X92	6X93	6X94	6X95	6X96	6X97	6X98	6X99	6X100

R-800 AUDIO SECTION



RF SECTION

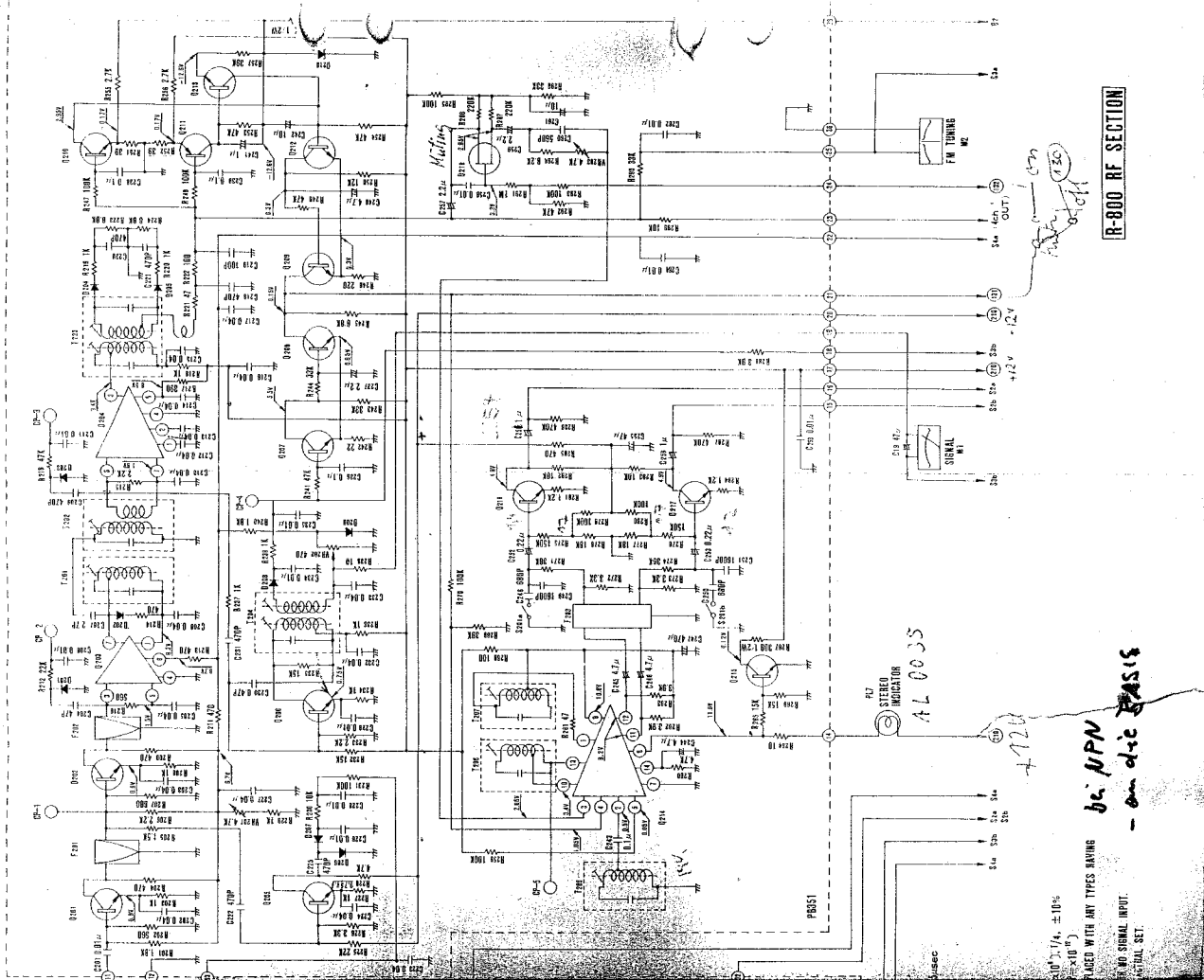

R-800 RF SECTION

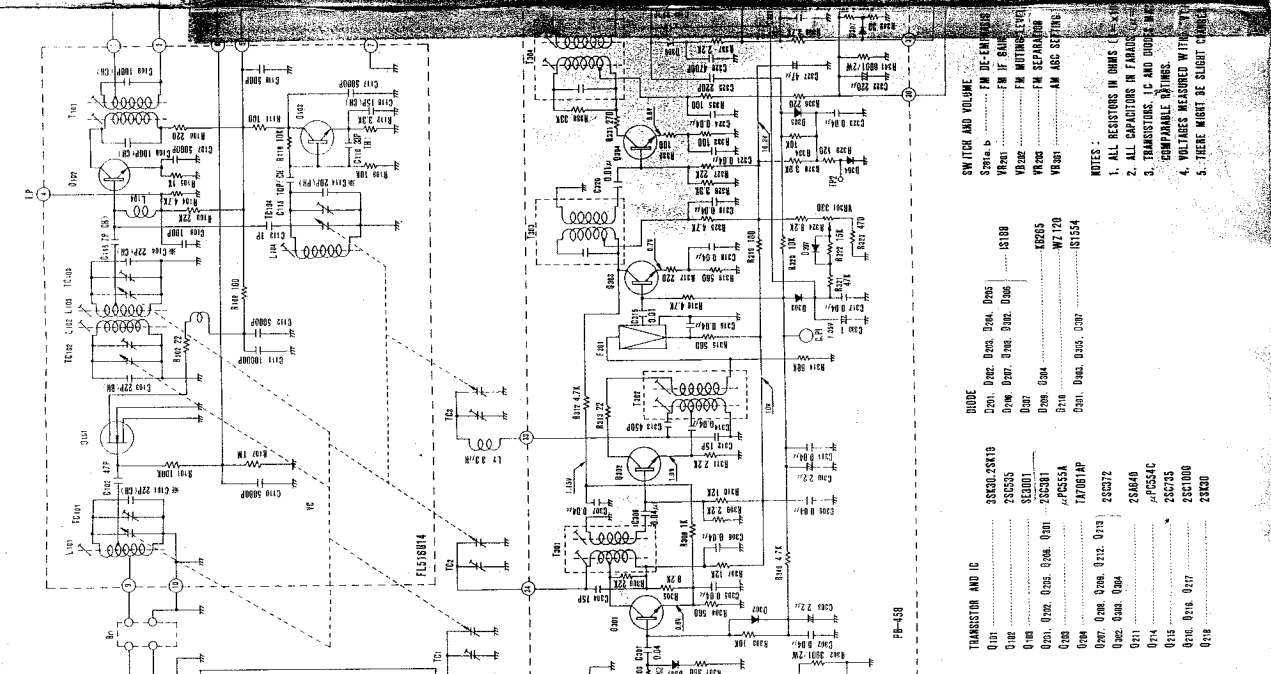

TRANSISTOR AND IC		DIODE		SWITCH AND VOLUME	
Q101	3SK500-02K19	D101	1N34A	SW1	FM DC-EMERGENCY
Q102	2S6535	D102	1N34A	SW2	FM IF GAIN
Q103	SECRET	D103	1N34A	SW3	FM MUTE/LEVEL
Q104	2S6535	D104	1N34A	SW4	FM SEPARATION
Q105	2S6535	D105	1N34A	SW5	AM/SS SEPARATION
Q106	2S6535	D106	1N34A	SW6	AM/SS SEPARATION
Q107	2S6535	D107	1N34A	SW7	AM/SS SEPARATION
Q108	2S6535	D108	1N34A	SW8	AM/SS SEPARATION
Q109	2S6535	D109	1N34A	SW9	AM/SS SEPARATION
Q110	2S6535	D110	1N34A	SW10	AM/SS SEPARATION

NOTES:

1. ALL RESISTORS IN OHMS (UNLESS OTHERWISE SPECIFIED).
2. ALL CAPACITORS IN FARADS (UNLESS OTHERWISE SPECIFIED).
3. TRANSISTORS, IC AND DIODES IN THIS SECTION ARE TO BE REPLACED WITH ANY TYPES HAVING EQUIVALENT CHARACTERISTICS.
4. VOLTAGES MEASURED WITH ANTI-PARALLEL DIODES.
5. THERE MUST BE SLIGHT CLEARANCE BETWEEN ALL PARTS.

STEREO INDICATOR AL 0035

bc. MPN
- on d-c BASIS

POWER T.H.D. (BOTH CH. DRIVEN)

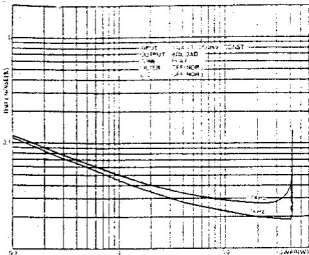

AUDIO SECTION

FREQUENCY T.H.D. (BOTH CH. DRIVEN)

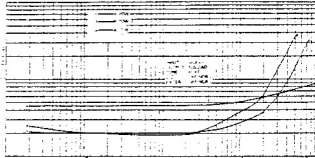

TONE CONTROL

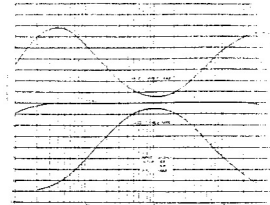

POWER IMD

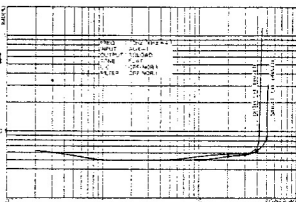

FILTER

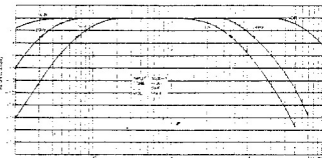

LOUDNESS/LOW BOOST

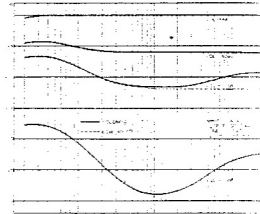

SELECTIVITY

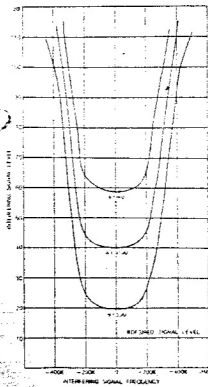

RF SECTION

FM CHARACTERISTIC

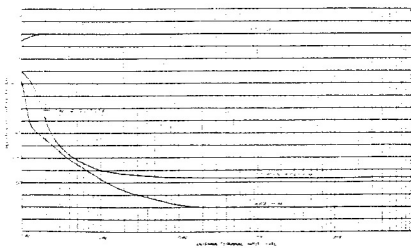

DISTORTION

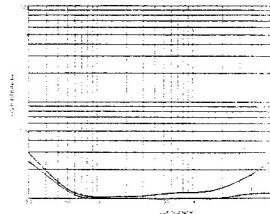

STEREO SEPARATION

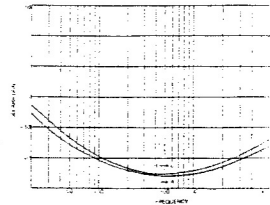



LUX CORPORATION, JAPAN

HEAD OFFICE & FACTORY 2-22, NAGAHASHI-DORI, NISHINARI-KU, OSAKA
PHONES: 632 0031 CABLE: LUXELECT OSAKA
INTERNATIONAL DIVISION NO. 13, 2-23, YUSHIMA, BUNKYO-KU, TOKYO
PHONES: 833 7691 CABLE: TOKLUXMAN TOKYO

Printed in Japan